

Data sheet | Item number: 280-685

4-conductor disconnect terminal block; for DIN-rail 35 x 15 and 35 x 7.5; 2.5 mm²; CAGE CLAMP®

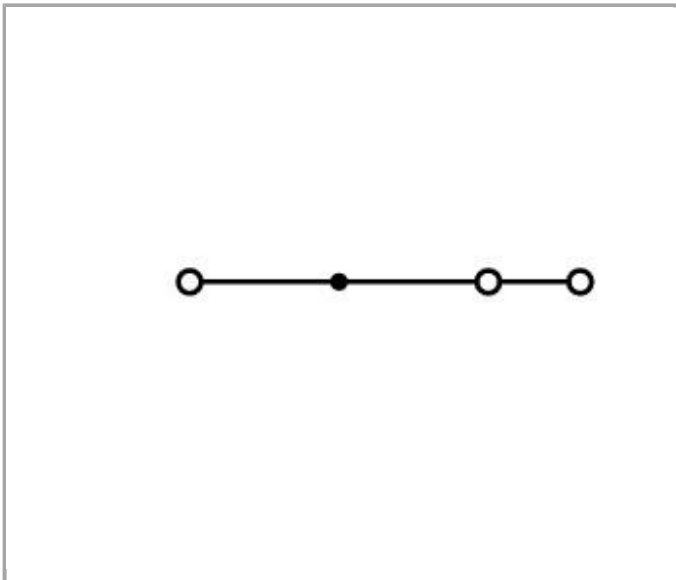

280-685

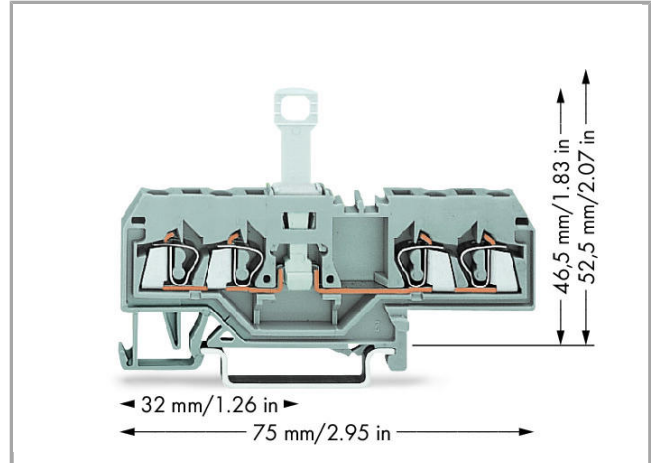
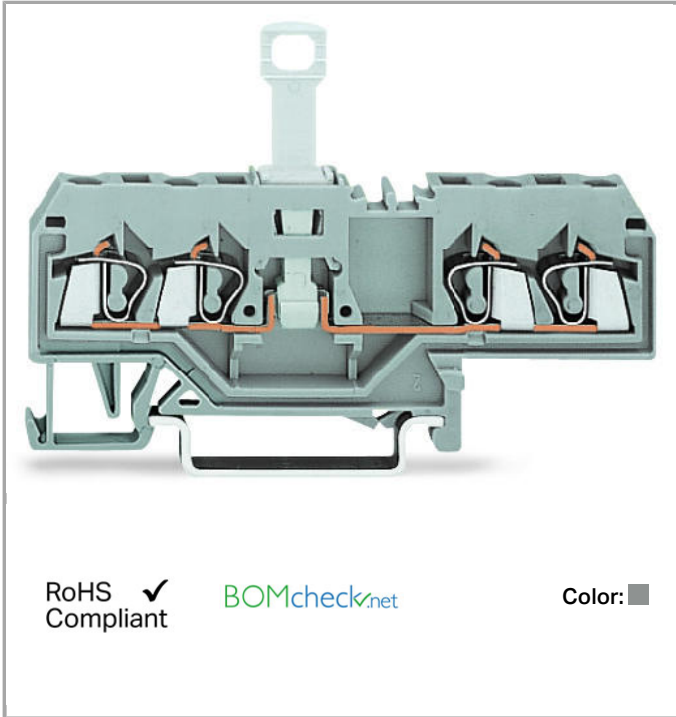

Item description

Note:

Terminating Aluminum Conductors

WAGO spring clamp terminal blocks are suitable for solid aluminum conductors up to 4 mm²/12 AWG if WAGO "Alu-Plus" Contact Paste is used for termination.

"Alu-Plus" Contact Paste Advantages:

- Automatically destroys the oxide film during clamping.
- Prevents fresh oxidation at the clamping point.
- Prevents electrolytic corrosion between aluminum and copper conductors (in the same terminal block).
- Provides long-term protection against corrosion.

Using terminal blocks with CAGE CLAMP® Spring Pressure Connection Technology, **aluminum conductors must first be cleaned with a blade and then immediately be inserted into the clamping units filled with "Alu-Plus" Contact Paste.**

It is also possible to apply WAGO "Alu-Plus" **additionally** on the whole surface of the aluminum conductor before termination.

Please note that the nominal currents must be adapted to the reduced conductivity of the aluminum conductors:

2.5 mm² (14 AWG) = 16 A

4 mm² (12 AWG) = 22 A

Data

Electrical data

Ratings per IEC/EN 60664-1

Rated voltage (III / 3)	400 V
Rated impulse voltage (III / 3)	6 kV
Rated current	10 A

Connection data

Connection technology	CAGE CLAMP®
Actuation type	Operating tool
Connectable conductor materials	Copper Aluminum
Solid conductor	0.08 ... 2.5 mm ² / 28 ... 12 AWG
Fine-stranded conductor	0.08 ... 2.5 mm ² / 28 ... 12 AWG
Strip length	8 ... 9 mm / 0.31 ... 0.35 inch
Note (conductor cross-section)	12 AWG: THHN, THWN
Total number of connection points	4
Total number of potentials	2
Number of levels	1
Type of wiring	Front-entry wiring

Geometrical Data

Width	5 mm / 0.197 inch
Height from upper-edge of DIN-35 rail	52.5 mm / 2.067 inch

Depth	75 mm / 2.953 inch
-------	--------------------

Mechanical data

Design	horizontal
Type of mounting	DIN-35 rail
Marking level	Center marking

Material Data

Color	gray
Insulating material	Polyamide 66 (PA 66)
Fire load	0.161 MJ
Weight	9.641 g

Commercial data

Product Group	1 (Rail Mounted Terminal Blocks)
Country of origin	DE
GTIN	4044918556811
Customs Tariff No.	85369010000

Approvals / Certificates

Country specific Approvals

Logo	Approval	Additional Approval Text	Certificate name
	CCA DEKRA Certification B.V.	EN 60947	2157201.01

	CSA DEKRA Certification B.V.	C22.2	1536071
--	--	-------	---------

Ship Approvals

Logo	Approval	Additional Approval Text	Certificate name
	ABS American Bureau of Shipping	EN 60947	14- HG1293677- PDA

	BV Bureau Veritas S.A.	EN 60947	07436/E0 BV
--	----------------------------------	----------	-------------



DNV GL
Det Norske Veritas, Germanischer Lloyd

-

TAE00001V2



LR
Lloyds Register

EN 60947





91/20112
(E9)















UL-Approvals















Logo	Approval	Additional Approval Text	Certificate name
	UL Underwriters Laboratories Inc.	UL 1059	20170731- E45172















Compatible products

Female plug

	Item no.: 232-132/005-000 Female connector for rail-mount terminal blocks; straight; Pin spacing 5 mm; 2-pole	/005-000	232-132
	Item no.: 232-132/005-000/039-000 Female connector for rail-mount terminal blocks; straight; Locking lever; Pin spacing 5 mm; 3-pole	/005-000/039-000	232-132
	Item no.: 232-133/005-000 Female connector for rail-mount terminal blocks; straight; Pin spacing 5 mm; 3-pole	/005-000	232-133
	Item no.: 232-133/005-000/039-000 Female connector for rail-mount terminal blocks; straight; Locking lever; Pin spacing 5 mm; 3-pole	/005-000/039-000	232-133
	Item no.: 232-134/005-000 Female connector for rail-mount terminal blocks; straight; Pin spacing 5 mm; 4-pole	/005-000	232-134

	Item no.: 232-134/005-000/039-000 Female connector for rail-mount terminal blocks; straight; Locking lever; Pin spacing 5 mm; 4-pole	232-134 /005-000/039-000
	Item no.: 232-135/005-000 Female connector for rail-mount terminal blocks; straight; Pin spacing 5 mm; 5-pole	232-135 /005-000
	Item no.: 232-135/005-000/039-000 Female connector for rail-mount terminal blocks; straight; Locking lever; Pin spacing 5 mm; 5-pole	232-135 /005-000/039-000
	Item no.: 232-136/005-000 Female connector for rail-mount terminal blocks; straight; Pin spacing 5 mm; 6-pole	232-136 /005-000
	Item no.: 232-136/005-000/039-000 Female connector for rail-mount terminal blocks; straight; Locking lever; Pin spacing 5 mm; 6-pole	232-136 /005-000/039-000
	Item no.: 232-137/005-000 Female connector for rail-mount terminal blocks; straight; Pin spacing 5 mm; 7-pole	232-137 /005-000
	Item no.: 232-137/005-000/039-000 Female connector for rail-mount terminal blocks; straight; Locking lever; Pin spacing 5 mm; 7-pole	232-137 /005-000/039-000
	Item no.: 232-138/005-000 Female connector for rail-mount terminal blocks; straight; Pin spacing 5 mm; 8-pole	232-138 /005-000
	Item no.: 232-138/005-000/039-000 Female connector for rail-mount terminal blocks; straight; Locking lever; Pin spacing 5 mm; 8-pole	232-138 /005-000/039-000
	Item no.: 232-139/005-000 Female connector for rail-mount terminal blocks; straight; Pin spacing 5 mm; 9-pole	232-139 /005-000
	Item no.: 232-139/005-000/039-000 Female connector for rail-mount terminal blocks; straight; Locking lever; Pin spacing 5 mm; 9-pole	232-139 /005-000/039-000
	Item no.: 232-140/005-000 Female connector for rail-mount terminal blocks; straight; Pin spacing 5 mm; 10-pole	232-140 /005-000
	Item no.: 232-140/005-000/039-000 Female connector for rail-mount terminal blocks; straight; Locking lever; Pin spacing 5 mm; 10-pole	232-140 /005-000/039-000
	Item no.: 232-142/005-000 Female connector for rail-mount terminal blocks; straight; Pin spacing 5 mm; 12-pole	232-142 /005-000
	Item no.: 232-142/005-000/039-000 Female connector for rail-mount terminal blocks; straight; Locking lever; Pin spacing 5 mm; 12-pole	232-142 /005-000/039-000

	Item no.: 232-146/005-000 Female connector for rail-mount terminal blocks; straight; Pin spacing 5 mm; 16-pole	232-146 /005-000
	Item no.: 232-146/005-000/039-000 Female connector for rail-mount terminal blocks; straight; Locking lever; Pin spacing 5 mm; 16-pole	232-146 /005-000/039-000
	Item no.: 232-147/005-000/039-000 Female connector for rail-mount terminal blocks; straight; Locking lever; Pin spacing 5 mm; 17-pole	232-147 /005-000/039-000
	Item no.: 232-150/005-000 Female connector for rail-mount terminal blocks; straight; Pin spacing 5 mm; 20-pole	232-150 /005-000
	Item no.: 232-150/005-000/039-000 Female connector for rail-mount terminal blocks; straight; Locking lever; Pin spacing 5 mm; 20-pole	232-150 /005-000/039-000
	Item no.: 232-232/005-000 Female connector for rail-mount terminal blocks; angled; Pin spacing 5 mm; 2-pole	232-232 /005-000
	Item no.: 232-232/005-000/039-000 Female connector for rail-mount terminal blocks; angled; Locking lever; Pin spacing 5 mm; 2-pole	232-232 /005-000/039-000
	Item no.: 232-233/005-000 Female connector for rail-mount terminal blocks; angled; Pin spacing 5 mm; 3-pole	232-233 /005-000
	Item no.: 232-233/005-000/039-000 Female connector for rail-mount terminal blocks; angled; Locking lever; Pin spacing 5 mm; 3-pole	232-233 /005-000/039-000
	Item no.: 232-234/005-000 Female connector for rail-mount terminal blocks; angled; Pin spacing 5 mm; 4-pole	232-234 /005-000
	Item no.: 232-234/005-000/039-000 Female connector for rail-mount terminal blocks; angled; Locking lever; Pin spacing 5 mm; 4-pole	232-234 /005-000/039-000
	Item no.: 232-235/005-000 Female connector for rail-mount terminal blocks; angled; Pin spacing 5 mm; 5-pole	232-235 /005-000
	Item no.: 232-235/005-000/039-000 Female connector for rail-mount terminal blocks; angled; Locking lever; Pin spacing 5 mm; 5-pole	232-235 /005-000/039-000
	Item no.: 232-236/005-000 Female connector for rail-mount terminal blocks; angled; Pin spacing 5 mm; 6-pole	232-236 /005-000

	Item no.: 232-236/005-000/039-000 Female connector for rail-mount terminal blocks; angled; Locking lever; Pin spacing 5 mm; 6-pole	232-236 /005-000/039-000
	Item no.: 232-237/005-000 Female connector for rail-mount terminal blocks; straight; Pin spacing 5 mm; 7-pole	232-237 /005-000
	Item no.: 232-238/005-000 Female connector for rail-mount terminal blocks; angled; Pin spacing 5 mm; 8-pole	232-238 /005-000
	Item no.: 232-239/005-000 Female connector for rail-mount terminal blocks; angled; Pin spacing 5 mm; 9-pole	232-239 /005-000
	Item no.: 232-240/005-000 Female connector for rail-mount terminal blocks; angled; Pin spacing 5 mm; 10-pole	232-240 /005-000
	Item no.: 232-240/005-000/039-000 Female connector for rail-mount terminal blocks; angled; Locking lever; Pin spacing 5 mm; 10-pole	232-240 /005-000/039-000
	Item no.: 232-242/005-000 Female connector for rail-mount terminal blocks; angled; Pin spacing 5 mm; 12-pole	232-242 /005-000
	Item no.: 232-242/005-000/039-000 Female connector for rail-mount terminal blocks; angled; Locking lever; Pin spacing 5 mm; 12-pole	232-242 /005-000/039-000
	Item no.: 232-246/005-000 Female connector for rail-mount terminal blocks; angled; Pin spacing 5 mm; 16-pole	232-246 /005-000
	Item no.: 232-246/005-000/039-000 Female connector for rail-mount terminal blocks; angled; Locking lever; Pin spacing 5 mm; 16-pole	232-246 /005-000/039-000
	Item no.: 232-250/005-000 Female connector for rail-mount terminal blocks; angled; Pin spacing 5 mm; 20-pole	232-250 /005-000
	Item no.: 232-250/005-000/039-000 Female connector for rail-mount terminal blocks; angled; Locking lever; Pin spacing 5 mm; 20-pole	232-250 /005-000/039-000
	Item no.: 232-732/005-000 Female connector for rail-mount terminal blocks; straight; Pin spacing 7.5 mm; 2-pole	232-732 /005-000
	Item no.: 232-733/005-000 Female connector for rail-mount terminal blocks; straight; Pin spacing 7.5 mm; 3-pole	232-733 /005-000
	Item no.: 232-734/005-000 Female connector for rail-mount terminal blocks; straight; Pin spacing 7.5 mm; 4-pole	232-734 /005-000



Item no.: 232-734/005-000/039-000

Female connector for rail-mount terminal blocks; straight; Pin spacing 7.5 mm; 4-pole

232-734

/005-000/039-000

Item no.: 232-735/005-000

Female connector for rail-mount terminal blocks; straight; Pin spacing 7.5 mm; 5-pole

232-735

/005-000

Item no.: 232-735/005-000/039-000

Female connector for rail-mount terminal blocks; straight; Pin spacing 7.5 mm; 5-pole

232-735

/005-000/039-000

Item no.: 232-736/005-000

Female connector for rail-mount terminal blocks; straight; Pin spacing 7.5 mm; 6-pole

232-736

/005-000

Item no.: 232-736/005-000/039-000

Female connector for rail-mount terminal blocks; straight; Pin spacing 7.5 mm; 6-pole

232-736

/005-000/039-000

Item no.: 232-738/005-000

Female connector for rail-mount terminal blocks; straight; Pin spacing 7.5 mm; 8-pole

232-738

/005-000

Item no.: 232-740/005-000

Female connector for rail-mount terminal blocks; straight; Pin spacing 7.5 mm; 10-pole

232-740

/005-000

Item no.: 232-742/005-000

Female connector for rail-mount terminal blocks; straight; Pin spacing 7.5 mm; 12-pole

232-742

/005-000

Item no.: 232-832/005-000

Female connector for rail-mount terminal blocks; angled; Pin spacing 7.5 mm; 2-pole

232-832

/005-000

Item no.: 232-833/005-000

Female connector for rail-mount terminal blocks; angled; Pin spacing 7.5 mm; 3-pole

232-833

/005-000

Item no.: 232-834/005-000

Female connector for rail-mount terminal blocks; angled; Pin spacing 7.5 mm; 4-pole

232-834

/005-000

Item no.: 232-836/005-000

Female connector for rail-mount terminal blocks; straight; Pin spacing 7.5 mm; 6-pole

232-836

/005-000

Item no.: 232-836/005-000/039-000

Female connector for rail-mount terminal blocks; angled; Pin spacing 7.5 mm; 6-pole

232-836















/005-000/039-000

Item no.: 232-840/005-000















Female connector for rail-mount terminal blocks; straight; Pin spacing 7.5 mm; 10-pole















232-840







/005-000

	Item no.: 232-842/005-000 Female connector for rail-mount terminal blocks; straight; Pin spacing 7.5 mm; 12-pole	232-842 /005-000
	Item no.: 722-132/005-000 Female connector for rail-mount terminal blocks; straight; 100% protected against mismatching; Pin spacing 5 mm; 2-pole	722-132 /005-000
	Item no.: 722-132/005-000/039-000 Female connector for rail-mount terminal blocks; straight; 100% protected against mismatching; Locking lever; Pin spacing 5 mm; 3-pole	722-132 /005-000/039-000
	Item no.: 722-133/005-000 Female connector for rail-mount terminal blocks; straight; 100% protected against mismatching; Pin spacing 5 mm; 3-pole	722-133 /005-000
	Item no.: 722-133/005-000/039-000 Female connector for rail-mount terminal blocks; straight; 100% protected against mismatching; Locking lever; Pin spacing 5 mm; 3-pole	722-133 /005-000/039-000
	Item no.: 722-134/005-000 Female connector for rail-mount terminal blocks; straight; 100% protected against mismatching; Pin spacing 5 mm; 4-pole	722-134 /005-000
	Item no.: 722-134/005-000/039-000 Female connector for rail-mount terminal blocks; straight; 100% protected against mismatching; Locking lever; Pin spacing 5 mm; 4-pole	722-134 /005-000/039-000
	Item no.: 722-135/005-000 Female connector for rail-mount terminal blocks; straight; 100% protected against mismatching; Pin spacing 5 mm; 5-pole	722-135 /005-000
	Item no.: 722-135/005-000/039-000 Female connector for rail-mount terminal blocks; straight; 100% protected against mismatching; Locking lever; Pin spacing 5 mm; 5-pole	722-135 /005-000/039-000
	Item no.: 722-136/005-000 Female connector for rail-mount terminal blocks; straight; 100% protected against mismatching; Pin spacing 5 mm; 6-pole	722-136 /005-000
	Item no.: 722-136/005-000/039-000 Female connector for rail-mount terminal blocks; straight; 100% protected against mismatching; Locking lever; Pin spacing 5 mm; 6-pole	722-136 /005-000/039-000
	Item no.: 722-137/005-000 Female connector for rail-mount terminal blocks; straight; 100% protected against mismatching; Pin spacing 5 mm; 7-pole	722-137 /005-000
	Item no.: 722-137/005-000/039-000 Female connector for rail-mount terminal blocks; straight; 100% protected against mismatching; Locking lever; Pin spacing 5 mm; 7-pole	722-137 /005-000/039-000
	Item no.: 722-138/005-000 Female connector for rail-mount terminal blocks; straight; 100% protected against mismatching; Pin spacing 5 mm; 8-pole	722-138 /005-000
	Item no.: 722-138/005-000/039-000 Female connector for rail-mount terminal blocks; straight; 100% protected against mismatching; Pin spacing 5 mm; 8-pole	722-138 /005-000/039-000

Locking lever; Pin spacing 5 mm; 8-pole

	Item no.: 722-139/005-000 Female connector for rail-mount terminal blocks; straight; 100% protected against mismatching; Pin spacing 5 mm; 9-pole	722-139 /005-000
	Item no.: 722-139/005-000/039-000 Female connector for rail-mount terminal blocks; straight; 100% protected against mismatching; Locking lever; Pin spacing 5 mm; 9-pole	722-139 /005-000/039-000
	Item no.: 722-140/005-000 Female connector for rail-mount terminal blocks; straight; 100% protected against mismatching; Pin spacing 5 mm; 10-pole	722-140 /005-000
	Item no.: 722-140/005-000/039-000 Female connector for rail-mount terminal blocks; straight; 100% protected against mismatching; Locking lever; Pin spacing 5 mm; 10-pole	722-140 /005-000/039-000
	Item no.: 722-141/005-000 Female connector for rail-mount terminal blocks; straight; 100% protected against mismatching; Pin spacing 5 mm; 11-pole	722-141 /005-000
	Item no.: 722-142/005-000 Female connector for rail-mount terminal blocks; straight; 100% protected against mismatching; Pin spacing 5 mm; 12-pole	722-142 /005-000
	Item no.: 722-142/005-007/039-000 Female connector for rail-mount terminal blocks; straight; 100% protected against mismatching; Locking lever; Pin spacing 5 mm; 12-pole	722-142 /005-007/039-000
	Item no.: 722-143/005-000 Female connector for rail-mount terminal blocks; angled; 100% protected against mismatching; Pin spacing 5 mm; 13-pole	722-143 /005-000
	Item no.: 722-144/005-000 Female connector for rail-mount terminal blocks; straight; 100% protected against mismatching; Pin spacing 5 mm; 14-pole	722-144 /005-000
	Item no.: 722-144/005-000/039-000 Female connector for rail-mount terminal blocks; straight; 100% protected against mismatching; Locking lever; Pin spacing 5 mm; 14-pole	722-144 /005-000/039-000
	Item no.: 722-145/005-000 Female connector for rail-mount terminal blocks; straight; 100% protected against mismatching; Pin spacing 5 mm; 15-pole	722-145 /005-000
	Item no.: 722-146/005-000 Female connector for rail-mount terminal blocks; straight; 100% protected against mismatching; Pin spacing 5 mm; 16-pole	722-146 /005-000
	Item no.: 722-146/005-000/039-000 Female connector for rail-mount terminal blocks; straight; 100% protected against mismatching; Locking lever; Pin spacing 5 mm; 16-pole	722-146 /005-000/039-000
	Item no.: 722-150/005-000 Female connector for rail-mount terminal blocks; straight; 100% protected against mismatching; Pin spacing 5 mm; 20-pole	722-150 /005-000
	Item no.: 722-150/005-000/039-000	

	Female connector for rail-mount terminal blocks; straight; 100% protected against mismatching; Locking lever; Pin spacing 5 mm; 20-pole	722-150 /005-000/039-000
	Item no.: 722-232/005-000 Female connector for rail-mount terminal blocks; angled; 100% protected against mismatching; Pin spacing 5 mm; 3-pole	722-232 /005-000
	Item no.: 722-232/005-000/039-000 Female connector for rail-mount terminal blocks; straight; 100% protected against mismatching; Locking lever; Pin spacing 5 mm; 3-pole	722-232 /005-000/039-000
	Item no.: 722-233/005-000 Female connector for rail-mount terminal blocks; angled; 100% protected against mismatching; Pin spacing 5 mm; 3-pole	722-233 /005-000
	Item no.: 722-233/005-000/039-000 Female connector for rail-mount terminal blocks; angled; 100% protected against mismatching; Locking lever; Pin spacing 5 mm; 3-pole	722-233 /005-000/039-000
	Item no.: 722-234/005-000 Female connector for rail-mount terminal blocks; angled; 100% protected against mismatching; Pin spacing 5 mm; 4-pole	722-234 /005-000
	Item no.: 722-234/005-000/039-000 Female connector for rail-mount terminal blocks; straight; 100% protected against mismatching; Locking lever; Pin spacing 5 mm; 4-pole	722-234 /005-000/039-000
	Item no.: 722-235/005-000 Female connector for rail-mount terminal blocks; angled; 100% protected against mismatching; Pin spacing 5 mm; 5-pole	722-235 /005-000
	Item no.: 722-235/005-000/039-000 Female connector for rail-mount terminal blocks; angled; 100% protected against mismatching; Locking lever; Pin spacing 5 mm; 5-pole	722-235 /005-000/039-000
	Item no.: 722-236/005-000 Female connector for rail-mount terminal blocks; angled; 100% protected against mismatching; Pin spacing 5 mm; 6-pole	722-236 /005-000
	Item no.: 722-236/005-000/039-000 Female connector for rail-mount terminal blocks; angled; 100% protected against mismatching; Locking lever; Pin spacing 5 mm; 6-pole	722-236 /005-000/039-000
	Item no.: 722-237/005-000 Female connector for rail-mount terminal blocks; angled; 100% protected against mismatching; Pin spacing 5 mm; 7-pole	722-237 /005-000
	Item no.: 722-237/005-000/039-000 Female connector for rail-mount terminal blocks; angled; 100% protected against mismatching; Locking lever; Pin spacing 5 mm; 7-pole	722-237 /005-000/039-000
	Item no.: 722-238/005-000 Female connector for rail-mount terminal blocks; angled; 100% protected against mismatching; Pin spacing 5 mm; 8-pole	722-238 /005-000
	Item no.: 722-239/005-000 Female connector for rail-mount terminal blocks; angled; 100% protected against mismatching; Pin spacing 5 mm; 9-pole	722-239 /005-000

	Item no.: 722-239/005-000/039-000 Female connector for rail-mount terminal blocks; angled; 100% protected against mismatching; Locking lever; Pin spacing 5 mm; 9-pole	722-239 /005-000/039-000
	Item no.: 722-240/005-000 Female connector for rail-mount terminal blocks; angled; 100% protected against mismatching; Pin spacing 5 mm; 10-pole	722-240 /005-000
	Item no.: 722-240/005-000/039-000 Female connector for rail-mount terminal blocks; angled; 100% protected against mismatching; Locking lever; Pin spacing 5 mm; 10-pole	722-240 /005-000/039-000
	Item no.: 722-241/005-000 Female connector for rail-mount terminal blocks; straight; 100% protected against mismatching; Pin spacing 5 mm; 11-pole	722-241 /005-000
	Item no.: 722-242/005-000 Female connector for rail-mount terminal blocks; angled; 100% protected against mismatching; Pin spacing 5 mm; 12-pole	722-242 /005-000
	Item no.: 722-242/005-000/039-000 Female connector for rail-mount terminal blocks; angled; 100% protected against mismatching; Locking lever; Pin spacing 5 mm; 12-pole	722-242 /005-000/039-000
	Item no.: 722-243/005-000 Female connector for rail-mount terminal blocks; angled; 100% protected against mismatching; Pin spacing 5 mm; 13-pole	722-243 /005-000
	Item no.: 722-244/005-000 Female connector for rail-mount terminal blocks; angled; 100% protected against mismatching; Pin spacing 5 mm; 14-pole	722-244 /005-000
	Item no.: 722-244/005-000/039-000 Female connector for rail-mount terminal blocks; angled; 100% protected against mismatching; Locking lever; Pin spacing 5 mm; 14-pole	722-244 /005-000/039-000
	Item no.: 722-246/005-000 Female connector for rail-mount terminal blocks; angled; 100% protected against mismatching; Pin spacing 5 mm; 16-pole	722-246 /005-000
	Item no.: 722-246/005-000/039-000 Female connector for rail-mount terminal blocks; angled; 100% protected against mismatching; Locking lever; Pin spacing 5 mm; 16-pole	722-246 /005-000/039-000
	Item no.: 722-250/005-000 Female connector for rail-mount terminal blocks; angled; 100% protected against mismatching; Pin spacing 5 mm; 20-pole	722-250 /005-000

Protective Warning Marker

	Item no.: 280-415 Protective warning marker; with high-voltage symbol, black; for 5 terminal blocks	280-415
--	---	---------

check

	Item no.: 210-136 Test plug; 2 mm Ø; with 500 mm cable	210-136
	Item no.: 210-137 Test plug; 2.3 mm Ø; with 500 mm cable	210-137



Item no.: 249-141
L-type test plug module; modular; with spring-loaded contact pin; Center module

249-141

Jumper



Item no.: 210-103
Wire commoning chain; insulated; 50 connections

210-103

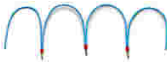

Item no.: 210-123
Wire commoning chain; insulated; 50 connections

210-123



Item no.: 280-482
Comb-style jumper bar; insulated; 2-way; IN = IN terminal block

280-482



Item no.: 280-483
Comb-style jumper bar; insulated; 3-way; IN = IN terminal block

280-483



Item no.: 280-484
Comb-style jumper bar; insulated; 4-way; IN = IN terminal block

280-484



Item no.: 280-485
Comb-style jumper bar; insulated; 5-way; IN = IN terminal block

280-485



Item no.: 280-490
Comb-style jumper bar; insulated; 10-way; IN = IN terminal block

280-490



Item no.: 280-492
Alternate comb-style jumper bar; insulated; 2-way; IN = IN terminal block

280-492



Item no.: 709-110
Wire commoning chain; insulated; 4 connections; 3 x 110 mm

709-110



Item no.: 709-111
Wire commoning chain; insulated; 3 connections; 2 x 120 mm

709-111



Item no.: 709-112
Wire commoning chain; insulated; 3 connections; 2 x 170 mm

709-112

Insulation stop



Item no.: 280-470
Insulation stop; 0.08 - 0.2 mm² "s" (0.14 mm² "f-st"); 5 pieces/strip

280-470



Item no.: 280-471
Insulation stop; 0.25 - 0.5 mm²; 5 pieces/strip

280-471



Item no.: 280-472
Insulation stop; 0.75 - 1 mm²; 5 pieces/strip

280-472

End plate



Item no.: 280-314
End and intermediate plate; 2.5 mm thick

280-314





















Item no.: 280-315
End and intermediate plate; 2.5 mm thick

















280-315

































Item no.: 280-334
Separator plate; 2 mm thick; oversized









280-334

	Item no.: 280-335 Separator plate; 2 mm thick; oversized	280-335
Carrier rail		
	Item no.: 210-112 Steel carrier rail; 35 x 7.5 mm; 1 mm thick; 2 m long; slotted; according to EN 60715; "Hole width 25 mm	210-112
	Item no.: 210-113 Steel carrier rail; 35 x 7.5 mm; 1 mm thick; 2 m long; unslotted; according to EN 60715	210-113
	Item no.: 210-114 Steel carrier rail; 35 x 15 mm; 1.5 mm thick; 2 m long; unslotted; similar to EN 60715	210-114
	Item no.: 210-115 Steel carrier rail; 35 x 7.5 mm; 1 mm thick; 2 m long; slotted; according to EN 60715; "Hole width 18 mm	210-115
	Item no.: 210-118 Steel carrier rail; 35 x 15 mm; 2.3 mm thick; 2 m long; unslotted; according to EN 60715	210-118
	Item no.: 210-196 Aluminum carrier rail; 35 x 8.2 mm; 1.6 mm thick; 2 m long; unslotted; similar to EN 60715	210-196
	Item no.: 210-197 Steel carrier rail; 35 x 15 mm; 1.5 mm thick; 2 m long; slotted; similar to EN 60715	210-197
	Item no.: 210-198 Copper carrier rail; 35 x 15 mm; 2.3 mm thick; 2 m long; unslotted; according to EN 60715	210-198
	Item no.: 210-504 Steel carrier rail; 35 x 7.5 mm; 1 mm thick; 2 m long; slotted; galvanized; according to EN 60715	210-504
	Item no.: 210-505 Steel carrier rail; 35 x 7.5 mm; 1 mm thick; 2 m long; unslotted; galvanized; according to EN 60715	210-505
	Item no.: 210-506 Steel carrier rail; 35 x 15 mm; 1.5 mm thick; 2 m long; unslotted; galvanized; similar to EN 60715	210-506
	Item no.: 210-508 Steel carrier rail; 35 x 15 mm; 1.5 mm thick; 2 m long; slotted; galvanized; similar to EN 60715	210-508
assembling		
	Item no.: 209-106 Mounting carrier; for isolated mounting on DIN 35 rails	209-106
	Item no.: 709-154 Cover; Type 2; suitable for cover carrier, type 2; 1 m long	709-154
ferrule		
	Item no.: 216-101 Ferrule; Sleeve for 0.5 mm ² / AWG 22; uninsulated; electro-tin plated	216-101
	Item no.: 216-102 Ferrule; Sleeve for 0.75 mm ² / AWG 20; uninsulated; electro-tin plated	216-102
	Item no.: 216-103 Ferrule; Sleeve for 1 mm ² / AWG 18; uninsulated; electro-tin plated	216-103

	Item no.: 216-104 Ferrule; Sleeve for 1.5 mm ² / AWG 16; uninsulated; electro-tin plated	216-104
	Item no.: 216-201 Ferrule; Sleeve for 0.5 mm ² / 20 AWG; insulated; electro-tin plated	216-201
	Item no.: 216-202 Ferrule; Sleeve for 0.75 mm ² / 18 AWG; insulated; electro-tin plated	216-202
	Item no.: 216-203 Ferrule; Sleeve for 1 mm ² / AWG 18; insulated; electro-tin plated	216-203
	Item no.: 216-204 Ferrule; Sleeve for 1.5 mm ² / AWG 16; insulated; electro-tin plated	216-204
	Item no.: 216-301 Ferrule; Sleeve for 0.25 mm ² / AWG 24; insulated; electro-tin plated	216-301
	Item no.: 216-302 Ferrule; Sleeve for 0.34 mm ² / 22 AWG; insulated; electro-tin plated	216-302
Marking accessories		
	Item no.: 2009-115 WMB-Inline; for Smart Printer; on reel; stretchable 5 - 5.2 mm; plain; snap-on type	2009-115
	Item no.: 2009-115/000-002 WMB-Inline; for Smart Printer; on reel; stretchable 5 - 5.2 mm; plain; snap-on type	2009-115 /000-002
	Item no.: 2009-115/000-006 WMB-Inline; for smartPRINTER; on reel; stretchable 5 - 5.2 mm; plain; snap-on type	2009-115 /000-006
	Item no.: 2009-115/000-007 WMB-Inline; for Smart Printer; on reel; stretchable 5 - 5.2 mm; plain; snap-on type	2009-115 /000-007
	Item no.: 2009-115/000-012 WMB-Inline; for smartPRINTER; on reel; stretchable 5 - 5.2 mm; plain; snap-on type	2009-115 /000-012
	Item no.: 2009-115/000-017 WMB-Inline; for Smart Printer; on reel; stretchable 5 - 5.2 mm; plain; snap-on type	2009-115 /000-017
	Item no.: 2009-115/000-023 WMB-Inline; for Smart Printer; on reel; stretchable 5 - 5.2 mm; plain; snap-on type	2009-115 /000-023
	Item no.: 2009-115/000-024 WMB-Inline; for smartPRINTER; on reel; stretchable 5 - 5.2 mm; plain; snap-on type	2009-115 /000-024
	Item no.: 793-501 WMB marking card; as card; not stretchable; plain; snap-on type	793-501
	Item no.: 793-501/000-002 WMB marking card; as card; not stretchable; plain; snap-on type	793-501 /000-002

	Item no.: 793-501/000-005 WMB marking card; as card; not stretchable; plain; snap-on type	/000-005	793-501
	Item no.: 793-501/000-006 WMB marking card; as card; not stretchable; plain; snap-on type	/000-006	793-501
	Item no.: 793-501/000-007 WMB marking card; as card; not stretchable; plain; snap-on type	/000-007	793-501
	Item no.: 793-501/000-012 WMB marking card; as card; not stretchable; plain; snap-on type	/000-012	793-501
	Item no.: 793-501/000-017 WMB marking card; as card; not stretchable; plain; snap-on type	/000-017	793-501
	Item no.: 793-501/000-023 WMB marking card; as card; not stretchable; plain; snap-on type	/000-023	793-501
	Item no.: 793-501/000-024 WMB marking card; as card; not stretchable; plain; snap-on type	/000-024	793-501
	Item no.: 793-5501 WMB marking card; as card; for terminal block width 5 - 17.5 mm; stretchable 5 - 5.2 mm; plain; snap-on type		793-5501
	Item no.: 793-5501/000-002 WMB marking card; as card; for terminal block width 5 - 17.5 mm; stretchable 5 - 5.2 mm; plain; snap-on type	/000-002	793-5501
	Item no.: 793-5501/000-005 WMB marking card; as card; stretchable 5 - 5.2 mm; plain; snap-on type	/000-005	793-5501
	Item no.: 793-5501/000-006 WMB marking card; as card; stretchable 5 - 5.2 mm; plain; snap-on type	/000-006	793-5501
	Item no.: 793-5501/000-007 WMB marking card; as card; stretchable 5 - 5.2 mm; plain; snap-on type	/000-007	793-5501
	Item no.: 793-5501/000-012 WMB marking card; as card; stretchable 5 - 5.2 mm; plain; snap-on type	/000-012	793-5501
	Item no.: 793-5501/000-017 WMB marking card; as card; stretchable 5 - 5.2 mm; plain; snap-on type	/000-017	793-5501
	Item no.: 793-5501/000-023 WMB marking card; as card; stretchable 5 - 5.2 mm; plain; snap-on type	/000-023	793-5501

	Item no.: 793-5501/000-024 WMB marking card; as card; stretchable 5 - 5.2 mm; plain; snap-on type	793-5501 /000-024
tools		
	Item no.: 210-657 Operating tool with partially insulated shaft; Blade (3.5 x 0.5) mm; short	210-657
	Item no.: 210-658 Operating tool with partially insulated shaft; Blade (3.5 x 0.5) mm; short; angled	210-658
	Item no.: 210-720 Operating tool with partially insulated shaft; Type 2, blade (3.5 x 0.5) mm	210-720
General accessories		
	Item no.: 209-107 Test socket; insulated; 2 mm Ø	209-107
	Item no.: 209-108 Test socket; insulated; 2.3 mm Ø	209-108
	Item no.: 231-162/003-000 Male connector for rail-mount terminal blocks; 1.2 x 1.2 mm pins; straight; Pin spacing 5 mm; 2-pole	231-162 /003-000
	Item no.: 231-163/003-000 Male connector for rail-mount terminal blocks; 1.2 x 1.2 mm pins; straight; Pin spacing 5 mm; 3-pole	231-163 /003-000
	Item no.: 231-164/003-000 Male connector for rail-mount terminal blocks; 1.2 x 1.2 mm pins; straight; Pin spacing 5 mm; 4-pole	231-164 /003-000
	Item no.: 231-165/003-000 Male connector for rail-mount terminal blocks; 1.2 x 1.2 mm pins; straight; Pin spacing 5 mm; 5-pole	231-165 /003-000
	Item no.: 231-166/003-000 Male connector for rail-mount terminal blocks; 1.2 x 1.2 mm pins; straight; Pin spacing 5 mm; 6-pole	231-166 /003-000
	Item no.: 231-167/003-000 Male connector for rail-mount terminal blocks; 1.2 x 1.2 mm pins; straight; Pin spacing 5 mm; 7-pole	231-167 /003-000
	Item no.: 231-168/003-000 Male connector for rail-mount terminal blocks; 1.2 x 1.2 mm pins; straight; Pin spacing 5 mm; 8-pole	231-168 /003-000
	Item no.: 231-169/003-000 Male connector for rail-mount terminal blocks; 1.2 x 1.2 mm pins; straight; Pin spacing 5 mm; 9-pole	231-169 /003-000
	Item no.: 231-170/003-000 Male connector for rail-mount terminal blocks; 1.2 x 1.2 mm pins; straight; Pin spacing 5 mm; 10-pole	231-170 /003-000

	Item no.: 231-171/003-000 Male connector for rail-mount terminal blocks; 1.2 x 1.2 mm pins; straight; Pin spacing 5 mm; 11-pole / 003-000	231-171
	Item no.: 231-172/003-000 Male connector for rail-mount terminal blocks; 1.2 x 1.2 mm pins; straight; Pin spacing 5 mm; 12-pole / 003-000	231-172
	Item no.: 231-176/003-000 Male connector for rail-mount terminal blocks; 1.2 x 1.2 mm pins; straight; Pin spacing 5 mm; 16-pole / 003-000	231-176
	Item no.: 231-180/003-000 Male connector for rail-mount terminal blocks; 1.2 x 1.2 mm pins; straight; Pin spacing 5 mm; 20-pole / 003-000	231-180
	Item no.: 231-668 Lockout caps; for covering unused clamping units	231-668
	Item no.: 231-669 Lockout caps; for covering unused clamping units	231-669
	Item no.: 249-105 Group marker carrier	249-105
	Item no.: 709-170 Disconnect lock; for disconnect tab used on 280/281 and 769 Series disconnect terminal blocks	709-170

Downloads

CAD/CAE - Smart Data

CAD data

	URL	Download
3D Download 280-685		

Subject to changes.